

## Multi-Basket Strainers and Multi-Bag Filters

These multi-basket strainers and bag filters offer a wide range of flow capacities and contaminant-holding capabilities. They contain from 2 to 23 baskets.

To serve as a strainer, a unit is ordered with perforated stainless steel baskets (mesh-lined if desired). When ordered as a filter, it's fitted with perforated stainless steel baskets designed to hold disposable or cleanable filter bags. Industry-standard size bags are used: the standard 30 inch baskets accept bag size 2, the optional 15 inch baskets take size 1.

The standard pressure rating for all models is 150 psi. All housings can be supplied with an ASME code stamp, if required.

### Features

- NSF 61 listed
- Multiple housing styles available (standard, quick access, low profile, hinged)
- Permanently piped housings are opened without tools and without disturbing the piping
- Machined cover gasket groove provides positive O-ring sealing
- Carbon steel, 304 or 316 stainless steel construction housings
- Large-area, 30 inch deep, heavy-duty, 9/64 inch perforated baskets
- Easy to clean
- Low pressure drop
- Four cover seal materials: Buna N, Ethylene Propylene, Viton®, and Teflon®
- Pressure rating 150 psi
- Flanged connections for 2 through 12 inch pipe
- Vent, drain and gage connections



### Options

- ASME code stamp
- Higher pressure ratings
- Corrosion allowances
- Steam jackets



- Special connection locations
- Bag hold down assembly (standard on QII design)
- Inner baskets for dual-stage straining or filtering
- Cleanable wire mesh lined or perforated strainer baskets
- Special alloy materials
- Hydraulic cover lifting assembly
- Sanitary fittings
- Differential pressure indicators

### Duplex Systems

All multi-basket models described here are also available as duplex systems. Two units come piped together with valves to permit continuous use of either unit while servicing the other. One lever actuates all valves simultaneously or it can be ordered for automatic service. See page 65.

## **R** Choose Housing Style

Designed to suit your requirements

The versatility of Rosedale Products provides a choice of several different designs.

- **Standard Housing Design (STD)** is durable and economic. It includes a davit arm and handwheel to facilitate cover removal. It is our most versatile housing design offering a variety of options, including our low profile design.

- **Spring Access Cover Design (HLP)** opens and closes without effort. Simply loosen the swing bolts and lift the cover up to open. An automatic cover stop is provided. See page 37 for details.

- **Quick Access Cover (QII)** features a unique counter weight design that makes opening, closing, and change-out, fast, easy, and simple. This will significantly reduce change-out time and lower operating costs. The QAC is rated to 150 PSI and constructed to meet ASME code requirements. Built-in safety features ensure that the cover cannot be opened unless the internal pressure is first released. The QII is offered with our low profile design making bags more accessible and easy to remove.

- **Low Profile Design (SLP) Housings** are compact and space saving, allowing for ease of bag change-out. Standard operating height is reduced, resulting in a safe design by eliminating platforms and ladders. The SLP is manufactured in any housing version, including our standard davit arm cover, QAC design, and spring assisted hinged cover.



Standard Davit Arm



Spring Access Cover



QII Quick Access Cover



Low Profile Design

## **R** Choose Baskets That Strain or Filter

Whatever your needs dictate

Strainer baskets are cleanable, reusable.

A seal is supplied on any strainer basket. It forms a seal between basket and housing to prevent dirty fluid bypass. Choose between various perforation sizes or wire mesh. Strainer baskets have flat, non-perforated bottoms and contain heavy-duty handles.

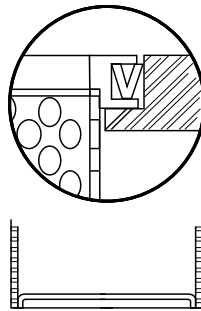

Filter bag baskets hold disposable filter bags.

Filter bags have an interference fit between the bags top rim and the housing causing a positive seal to prevent fluid bypass. Filter bag baskets have flat perforated bottoms.

Filter bags are available in a wide variety of felt, micro-fiber, monofilament and multifilament mesh materials. They are detailed completely on pages 134.

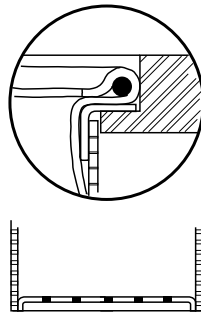

DUAL-STAGE— Dual-stage action will increase strainer or filter life and reduce servicing needs. This straining/filtering action can be achieved by ordering a second, inner basket. It is supported on the top flange of the outer basket. Both baskets can be utilized as strainers (with or without wire mesh linings), filter bag baskets, or a combination of strainer and bag basket.



### **Basket Data**

Surface area of each 30 in. basket: 4.4 sq. ft.

Volume of each 30 in. basket: 0.6 cu. ft.

### **Basket Construction**

For cleanable strainer baskets, choose from the following perforation diameters: 1/4, 3/16, 9/64, 3/32, or 1/16 inch (for other not shown consult factory).

Any perforated basket can also be ordered lined with wire mesh. Stainless steel wire is used in mesh sizes 20, 30, 40, 50, 60, 70, 80, 100, 150, or 200.

Filter bag baskets, have standard 9/64 inch diameter perforations that are 51% open area. A wire mesh can also be utilized with bag baskets for two advantages:

1. Fiber migration is minimized.
2. In the unlikely event of bag rupture, the wire mesh better contains the contaminant.

# Q II



**SAFETY VALVE MECHANISM**



**COUNTER BALANCED COVER**



**HANDWHEEL OPERATION OF TURNBUCKLE MECHANISM**



**ELEMENT/BAG RETAINING DEVICE**

M U L T I - B A S K E T S T R A I N E R S A N D M U L T I - B A G F I L T E R S

MODEL NUMBER & Dim. A	Pipe Sizes B	Leg Bolt Circle Dia.	Standard						Low Profile				
			C	D	E	F	G	Weight, lb (Approx)	H	I	J	K	L
16	2	14.0	10.9	40.1	57.1	4.50	10.5	400	37.9	54.9	8.00	15.0	13.0
	3		42.5	59.5	5.25	12.3	425	38.3	55.3	9.00	17.0	14.0	
	4		44.9	61.9	6.00	14.0	450	N/A	N/A	N/A	N/A	N/A	
18	2	16.0	11.9	40.5	58.0	4.50	11.1	450	39.6	58.5	8.00	15.0	14.0
	3		42.9	60.4	5.25	12.9	475	40.0	58.9	9.00	17.0	15.0	
	4		45.3	62.8	6.00	14.6	500	N/A	N/A	N/A	N/A	N/A	
22	2	20.0	14.0	41.4	60.0	4.50	11.9	485	39.5	58.0	8.00	15.0	16.0
	3		43.9	62.4	5.25	13.7	500	40.0	58.5	9.00	17.0	17.0	
	4		46.2	64.7	6.00	15.4	515	39.5	58.0	9.00	19.0	18.0	
	6		50.4	69.0	7.00	18.9	560	N/A	N/A	N/A	N/A	N/A	
24	2	22.0	15.0	41.7	60.7	4.50	13.1	675	41.2	61.6	8.00	15.0	17.0
	3		44.1	63.1	5.25	14.8	700	41.6	62.0	9.00	17.0	18.0	
	4		46.5	65.5	6.00	16.6	725	41.1	61.5	9.00	19.0	19.0	
	6		50.7	69.7	7.00	20.1	750	N/A	N/A	N/A	N/A	N/A	
30	2	28.0	18.0	42.8	63.3	4.50	15.2	635	41.3	61.9	8.00	15.0	20.5
	3		45.2	65.7	5.25	17.0	650	41.8	62.4	9.00	17.0	21.0	
	4		47.6	68.1	6.00	18.7	665	41.3	61.9	9.00	19.0	22.5	
	6		51.9	72.4	7.00	22.2	705	41.2	61.8	10.0	17.0	23.0	
	8		56.4	76.8	8.25	25.7	850	N/A	N/A	N/A	N/A	N/A	
36	3	34.0	21.0	46.4	68.4	5.25	18.8	840	43.3	64.5	9.00	17.0	24.0
	4		48.8	70.8	6.00	20.6	860	43.2	64.5	9.50	19.0	25.0	
	6		53.1	75.1	7.00	24.1	870	43.2	64.4	10.5	17.0	26.0	
	8		57.6	79.6	8.25	27.6	1010	43.2	64.4	11.5	17.0	27.0	
	10		62.1	84.1	9.50	30.6	1150	N/A	N/A	N/A	N/A	N/A	
42	4	40.0	24.0	50.0	73.5	6.00	22.6	1840	45.9	70.7	9.50	19.0	28.0
	6		54.3	77.8	7.00	26.1	1870	45.9	70.6	10.5	17.0	28.0	
	8		58.8	82.3	8.25	29.6	1960	45.9	70.6	11.5	17.0	29.5	
	10		63.3	86.8	9.50	32.6	2070	45.8	70.5	12.5	17.0	30.0	
	12		68.0	91.5	11.0	36.1	2200	N/A	N/A	N/A	N/A	N/A	
48	4	46.0	27.0	51.0	76.0	6.00	24.8	2015	46.5	71.5	9.50	19.0	32.0
	6		55.4	80.4	7.00	28.3	2075	46.4	71.4	10.5	17.0	32.0	
	8		60.0	85.0	8.25	31.8	2200	46.4	71.4	11.5	17.0	32.5	
	10		64.4	89.4	9.50	34.8	2350	46.4	71.4	12.5	17.0	33.0	
	12		69.2	94.2	11.0	38.3	2530	N/A	N/A	N/A	N/A	N/A	

**Dimensions (IN)**

(30-inch deep basket)

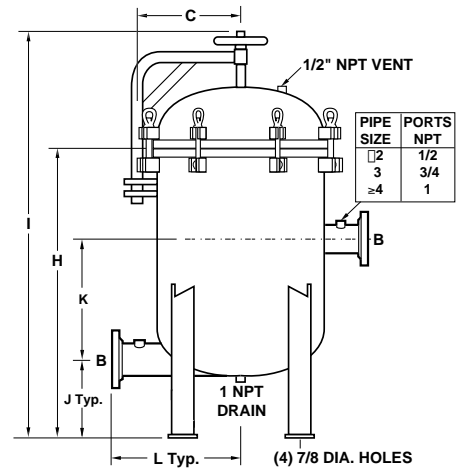
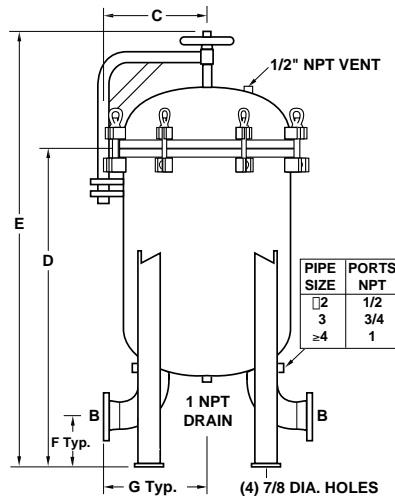
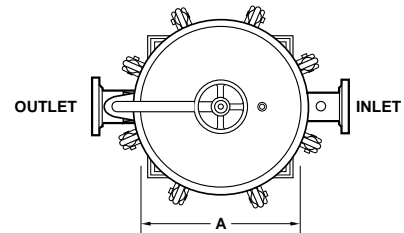
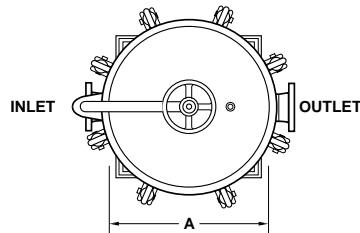

Dimensions are reference only and should not be used for hard plumbing. Consult factory for certified drawings.

**Standard**

**Low Profile**

MULTI-BASKET STRAINERS AND MULTI-BAG FILTERS

QII Low Profile									
MODEL NUMBER & Dim.	Leg Bolt Circle Dia. A	Pipe Size B	C	D	E	F	G	H	
16 & 18	16.0	18.0	2	40.0	53.2	8.00	15.0	14.0	35.5
			3	40.4	53.6	9.00	17.0	15.0	
22	22.0	24.0	2	41.5	56.2	8.00	15.0	16.0	35.5
			3	41.9	56.6	9.00	17.0	17.0	
24	22.0	24.0	4	41.4	56.1	9.00	19.0	18.0	
			2	41.5	56.2	8.00	15.0	17.0	38.5
30	28.0	30.0	3	41.9	56.6	9.00	17.0	18.0	
			4	41.4	56.1	9.00	19.0	19.0	
36	34.0	36.0	2	43.0	59.2	8.00	15.0	20.5	41.5
			3	43.4	59.6	9.00	17.0	21.0	
42	40.0	42.0	4	42.9	59.1	9.00	19.0	22.5	
			6	42.9	59.1	10.00	17.0	23.0	
48	46.0	48.0	3	44.9	62.6	9.00	17.0	24.0	44.5
			4	44.9	62.6	9.50	19.0	25.0	
48	46.0	48.0	6	44.9	62.6	10.5	17.0	29.5	
			8	44.9	62.6	11.5	17.0	27.0	
48	46.0	48.0	4	46.4	65.6	9.5	19.0	28.0	47.5
			6	46.4	65.6	10.5	17.0	28.0	
48	46.0	48.0	8	46.4	65.6	11.5	17.0	29.5	
			10	46.3	65.5	12.5	17.0	30.0	
48	46.0	48.0	4	47.9	68.6	9.5	19.0	32.0	50.5
			6	47.9	68.6	10.5	17.0	32.0	
48	46.0	48.0	8	47.9	68.6	11.5	17.0	32.5	
			10	47.8	68.5	12.5	17.0	33.0	

Model Selection (For all housings)

Model No.	Number of Baskets	Straining, Filtering Area, ft <sup>2</sup>	Nominal Flow Rate (gpm)**	Inlet/Outlet Size (in)
16	2	8.8	200	2,3,4*
18	3	13.2	300	2,3,4*
22	4	17.6	400	2,3,4,6*
24	6	26.4	600	2,3,4,6*
30	8	35.2	800	2,3,4,6,8*
36	12	52.8	1200	2,3,4,6,8,10*
42	17	74.8	1700	2,3,4,6,8,10,12*
48	23	101.2	2300	2,3,4,6,8,10,12*

\* Not available on SLP, HLP, and QII styles.  
 \*\* Nominal flow rate is based on water @ 1 psi ΔP. For optimum filtering effectiveness, a maximum fluid velocity of 10 ft/sec should be maintained.

Pressure Drop Data

Basket strainers and bag filters are usually selected so that the pressure drop does not exceed 2 psi, when they are clean. Higher pressure drops may be tolerated when contaminant loading is low.

Determining housing pressure drop:

The pressure drops shown on the graph are reliable for all multi-basket housings, including strainer baskets or bag filter (perforated only or mesh lined). The pressure drop of any housing is governed by the size of the inlet and outlet, not the vessel itself.

1. Using the desired pipe size and approximate flow rate, determine the basic pressure drop from the graph.
2. Multiply the pressure drop obtained in step 1 by the viscosity correction factor found in the accompanying table.
3. You now have the pressure drop for a clean multi-basket unit. If bag filters are employed, you must add the pressure drop they incur to get a true pressure drop for the assembly.

**Note:** Filter bags are specified separately. See pages 134.

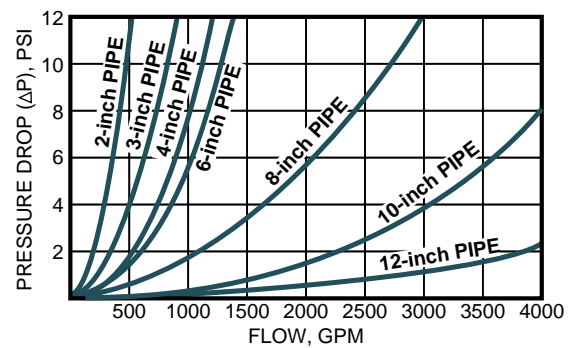

Recommended flow rates are based on housing only. Fluid viscosity, filter bag used, and expected dirt load should be considered when sizing a filter.

Dimensions (IN)

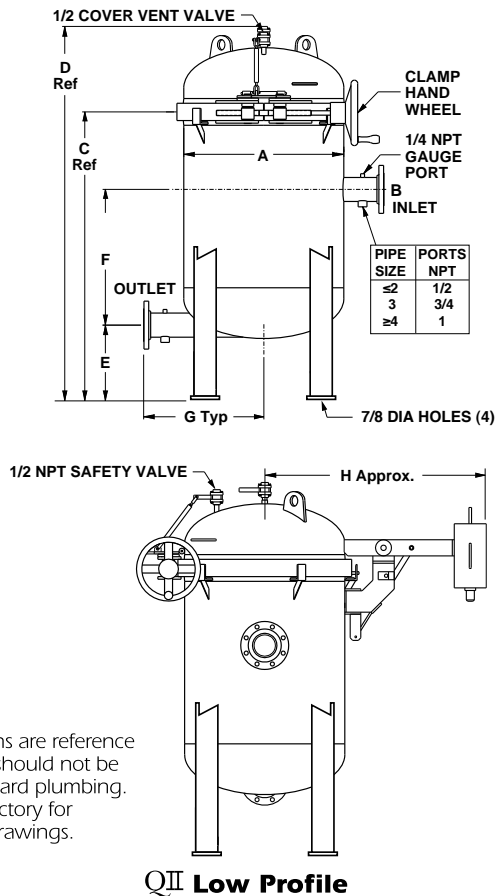

Dimensions are reference only and should not be used for hard plumbing. Consult factory for certified drawings.

QII Low Profile

Viscosity Factors

	CPS NUMBER								
	50	100	200	400	600	800	1000	2000	
(H <sub>2</sub> O)	.65	.85	1.00	1.10	1.20	1.40	1.50	1.60	1.80

# R How To Order

Build an ordering code as shown in the example

**Example:** **SLP-24-30-4F -1-150-C- B -S -M-20- C- 2P 1/16**

**Housings**      **Options**      **OPTIONAL INNER BASKET**

**HOUSING STYLE**  
 Standard (std) = **No Symbol**  
 Standard Low Profile = **SLP**  
 Quick Access Cover = **Q**

**MODEL NO.**  
 16 = **16**      30 = **30**  
 18 = **18**      36 = **36**  
 22 = **22**      42 = **42**  
 24 = **24**      48 = **48**

**BASKET DEPTH**  
 15-in. = **15**  
 30-in. (std) = **30**

**PIPE SIZE (FLANGED<sup>1</sup>)**  
 2-in. (Std, SLP, HLP 16-48 / OII 18 & 24) = **2F**  
 3-in. (Std, SLP, HLP 16-48 / OII 18 & 24) = **3F**  
 4-in. (Std 16-48 / SLP, HLP 22-48 / OII 24) = **4F**  
 6-in. (Std 22-48 / SLP, HLP 30-48) = **6F**  
 8-in. (Std 30-48 / SLP, HLP 36-48) = **8F**  
 10-in. (Std 36-48 / SLP, HLP 42 & 48) = **10F**  
 12-in. (Std 42, 48) = **12F**

**OUTLET STYLE**  
 In-line, bottom (std) = **1**  
 Side inlet/outlet (SLP, HLP, OII) = **2**  
 Side inlet/outlet, same side (SLP, HLP, OII) = **4**

**PRESSURE RATING<sup>2</sup>**  
 150 psi (flanged) = **150**

**HOUSING MATERIAL**  
 Carbon steel = **C**  
 304 stainless steel = **S**  
 316 stainless steel = **S316**

**\* COVER SEAL**  
 Buna N (N/A on Q housing) = **B**  
 Ethylene Propylene (N/A on Q housing) = **E**  
 Viton® = **V**  
 Teflon® Encapsulated Viton® (N/A on Q housing) = **TEV**  
 Teflon® (solid white) (N/A on Q housing) = **TSW**

**BASKET SEAL**  
 No seal = **N**  
 Seal (only on strainer housings) = **S**

**OPTIONAL INNER BASKET, MEDIA SIZE**  
 Perforation diameters (for type 2P baskets)  
**1/4, 3/16, 9/64, 3/32, 1/16**  
 Mesh sizes (for type 2M & 2BM baskets)  
**20, 30, 40, 50, 60, 70, 80, 100, 150, or 200**

**OPTIONAL INNER BASKET, TYPE**  
**2B** = Filter bag basket, 9/64 perforations  
**2P** = Strainer basket, perforated metal  
**2BM** = Filter basket, mesh lined  
**2M** = Strainer basket, perforated, mesh lined

**ASME CODE STAMP**  
**C** = Code  
**NSF** = NSF 61 listed

**BASKET, MEDIA SIZE No symbol if type B basket was selected**  
 Perforation diameters (for type P baskets)  
**1/4, 3/16, 9/64, 3/32, 1/16**  
 Mesh sizes (for type M & BM baskets)  
**20, 30, 40, 50, 60, 70, 80, 100, 150, or 200**

**BASKET, TYPE**  
**PB** = Filter bag basket, 9/64 perforations  
**P** = Strainer basket, perforated metal  
**BM** = Filter bag basket, perforated, mesh lined  
**M** = Strainer basket, perforated, mesh lined  
**HWM** = Filter bag basket, heavy wire mesh

1. Flanges provided with the housing match the pressure rating of the vessel. Housings rated 150 psi have 150 class flanges. Housings rated 300 psi have 300 class flanges. Other styles and classes available. ANSI B16.5 Pressure-Temperature rating tables determine flange class for ASME code housings. Consult factory.

2. Higher pressure ratings available. Consult factory.

**\*Note: Because of its unique Quick Access Cover, the Q (QII) housing style is available only with a Viton cover seal.**